

# User Manual

Z BOX-C ALL-IN-ONE ESS Cabinet



## C 215-2H

Product Model: C215L-A-EU

## **For your personal safety, please be sure to read and comply with the following safety requirements:**

This manual uses the following symbols to highlight important information:

**⚠ WARNING:** Indicates a hazard situation which, if not avoided, may result in serious injury or death.

**⚠ CAUTION:** Indicates a hazardous situation which, if not avoided, may result in minor injury or equipment damage.

**Notes:** Indicates important steps or techniques that give the best results, but are not related to safety or damage.

### **General information**

**Notes:** Maintenance personnel are required to hold a qualified electrician's certificate issued by the Safety Supervision Bureau or be authorized by the ZOE to carry out maintenance work.

**⚠ WARNING:** It is strictly forbidden to touch the high-voltage positive and negative posts of the energy storage system with both hands at any time.

**⚠ WARNING:** Ensure that the appropriate high and low voltage switches are disconnected before carrying out maintenance work on the energy storage system.

**⚠ WARNING:** When operating or maintaining the energy storage system, safety helmets, insulated gloves, insulated shoes and goggles are necessary, but metal jewelry such as watches are strictly prohibited.

**⚠ WARNING:** When cleaning the energy storage system, do not use water to clean the high and low voltage connectors directly.

**⚠ WARNING:** It is strictly prohibited to manually damage the storage battery by crushing, puncturing, burning, etc.

**⚠ WARNING:** The operating environment of the energy storage system should be free of corrosive, explosive and insulation-destroying gases or conductive dust, and far away from heat sources.

**⚠ WARNING:** It is prohibited to step on the top of the cabinet during usage and maintenance.

**⚠ WARNING:** If you have any questions, please contact the system supplier. Unauthorized operation is prohibited.

**⚠ WARNING:** Using it in series or parallel with other types of battery products is prohibited.

# Maintenance

## Environmental requirements

The cabinet is capable of charging and discharging within the operating temperature range specified below. At the extremes of this temperature range, the cabinet may limit the charging or discharging power to extend battery life.

<b>Charge temperature</b>	-20~55°C
<b>Discharge temperature</b>	-20~55°C

## Maintenance and cleaning

If installed outside, please keep the sides of the cabinet free of leaves and other debris to maintain optimal airflow.

⚠ **CAUTION:** Do not lean anything over the cabinet or hang anything on any internal or external wires or conduits.

⚠ **CAUTION:** To clean the cabinet, use a soft rag or lint-free rag. If necessary, only use the wet rag with neutral soapy water.

⚠ **CAUTION:** Do not use cleaning solvents to clean the cabinet or expose the cabinet to flammable or irritating chemicals or vapors.

## Maintenance



Energy storage cabinets, inlets and outlets do not require pre-scheduled preventive maintenance. The only maintenance required for user is to keep the energy storage cabinet unit clear and free of debris, especially near the air intake and exhaust ports.

# Table of Contents

<b>1. Important information.....</b>	<b>4</b>
1.1 Safety precautions.....	4
1.2 Intended use .....	4
1.3 About this manual .....	5
<b>2. Product overview .....</b>	<b>5</b>
2.1 Product structure .....	6
2.2 Product specification parameters .....	6
<b>3. Transportation and Storage .....</b>	<b>9</b>
3.1 Transportation .....	9
3.2 Storage .....	10
<b>4. Installation instructions .....</b>	<b>10</b>
4.1 Basic installation requirements .....	10
4.2 Layout requirements .....	11
4.3 Cabinet installation .....	12
4.4 Electrical connection.....	14
<b>5. Usage Instructions .....</b>	<b>17</b>
5.1 Confirmation of cable connection .....	17
5.2 Equipment powering on/off instructions .....	17
5.3 Upper computer operation instructions .....	21
5.4 Troubleshooting .....	22
<b>6. Product Maintenance .....</b>	<b>23</b>
6.1 Explanation of terms .....	23
6.2 Usage requirements for the energy storage cabinet in normal operation .....	23
6.3 Usage requirements for the energy storage cabinet in intermittent operation .....	23
6.4 Usage requirements for the energy storage cabinet unused for a long time .....	23
6.5 Function of the disconnecting switch .....	23
6.6 Maintaining energy storage cabinet .....	24
6.7 Maintenance requirements of liquid cooling systems .....	25
6.8 Fire fighting system maintenance .....	25
6.9 Check of air inlet and outlet .....	25
6.10 Electrical grounding system check .....	26
6.11 Appearance inspection .....	27
6.12 Maintenance cycle .....	27
<b>7. After-sales service .....</b>	<b>28</b>

# 1. Important Information

## 1.1 Safety precautions

Symbol	Meaning
	<p>Failure to follow safety precautions may result in mortal danger, injury and equipment damage. Claims arising therefrom will be rejected.</p> <ul style="list-style-type: none"><li>• <b>Electrical hazard</b></li></ul> <p>This cabinet must be installed by trained, qualified and authorized electrical installation personnel.</p> <p>Please observe the current standards and installation specifications before the first debugging and maintenance of this cabinet. Refer to “Installation instructions” for details.</p> <ul style="list-style-type: none"><li>• <b>Electrical hazard/fire hazard</b></li></ul> <p>Do not use damaged, worn or dirty cables.</p> <ul style="list-style-type: none"><li>• <b>The owner (terminal user) must run the energy storage system in its optimal condition.</b></li></ul> <ul style="list-style-type: none"><li>➤ Regularly check the cables and shell of the energy storage system for damage (visual inspection).</li><li>➤ If the energy storage system is damaged, please shut it down and replace it immediately.</li><li>➤ Do not conduct maintenance without authorization. Instead, maintenance of the energy storage system must be carried out by the manufacturer.</li><li>➤ Do not refit or upgrade the energy storage system without authorization.</li><li>➤ Do not remove safety symbols, warning signs, nameplates, labels, pipe marks, etc.</li></ul>
	<p><b>Caution</b></p> <ul style="list-style-type: none"><li>• Risk of damage.</li><li>• Do not spray water (by garden hose, high-pressure washer, etc.) to clean the energy storage system.</li></ul>

## 1.2 Intended use

- This is an electrical energy management system (e.g. electrical energy storage and release) for outdoor use.
- Please observe the regulations of the country where the energy storage system is installed and connected.

- For the intended use, please follow the specified environmental conditions in all cases.
- The equipment is developed, manufactured, inspected, and registered in accordance with relevant safety standards. Failure to comply with the instructions and safety precautions for the intended use may result in property damage or health hazards.
- Please strictly follow the instructions in this manual. Otherwise, safety hazards or safety device failure may occur. Although there are relevant safety precautions in this manual, please observe the safety regulations and accident prevention regulations for proper use.

### 1.3 About this manual

- This manual is applicable to the following models: All-in-One Outdoor Energy Storage Cabinet (C215L-A-EU)
- This manual is intended for the following:
  - Terminal customers (outdoor cabinet users)
  - Debugging and service technicians

## 2. Product overview

This product takes the 105kW/215kWh liquid-cooled outdoor energy storage cabinet as the core equipment. Combined with the monitoring software of energy dispatch, it can manage the energy demand on the user's side and realize the all-around control of the energy storage site.

The energy storage system is capable of receiving commands from the energy dispatch system and interacting with the energy network and user loads in order to achieve timely storage and release of energy to meet customers' energy needs.

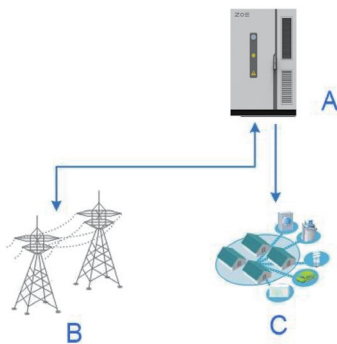

Figure 2.1 System Diagram

A: Outdoor energy storage cabinet

B: Energy network

C: Customer load

## 2.1 Product structure

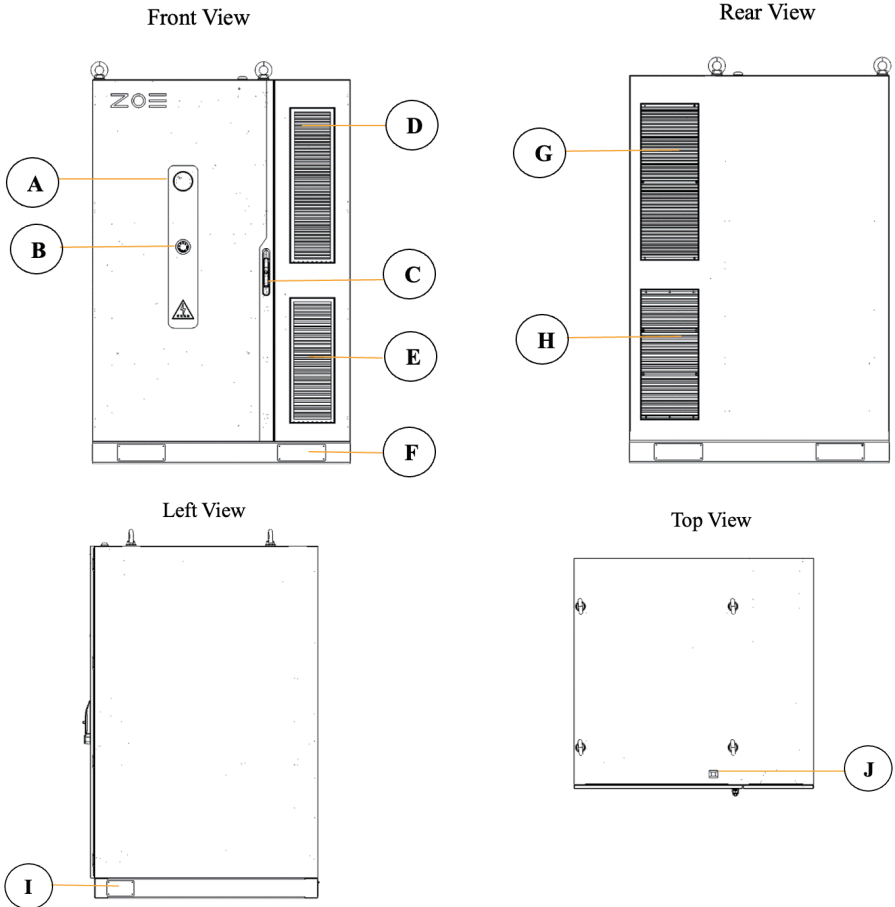

Figure 2.2 Product External Schematic Diagram

- [A]- Operation status indicator light
- [B]- Emergency stop
- [C]- Door lock
- [D]- Air inlet for liquid cooler
- [E]- Air inlet for PCS
- [F]- Forklift hole
- [G]- Exhaust vent for liquid cooler
- [H]- PCS exhaust vent, with 3 fans inside
- [I]- Side cable entry hole
- [J]- 4G antenna

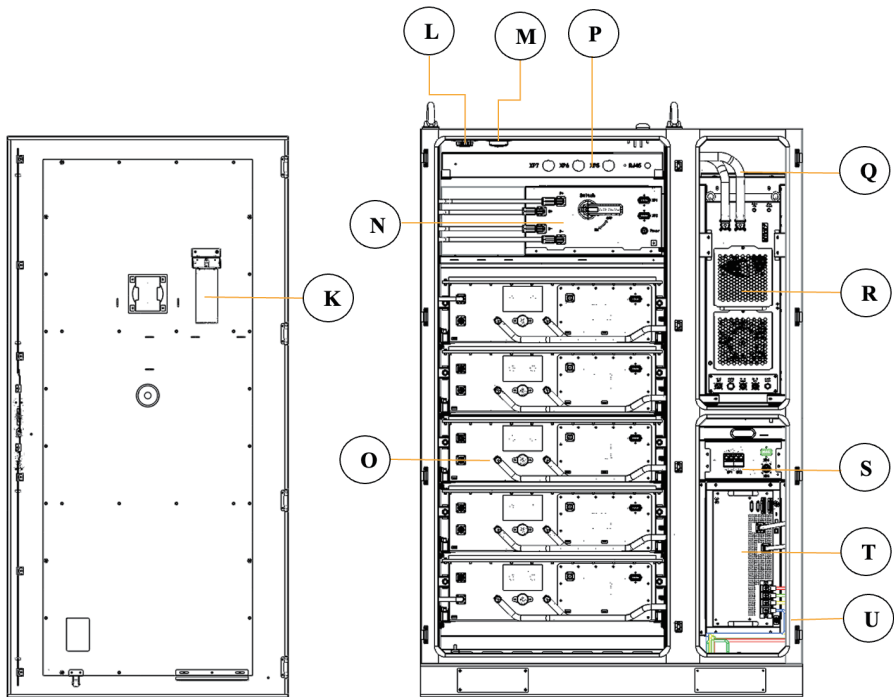

Figure 2.3 Product Internal Schematic Diagram

- [K]- Thermal aerosol fire extinguisher
- [L]- Smoke fire detector
- [M]- Temperature-sensitive fire detector
- [N]- High voltage box
- [O]- Battery module
- [P]- EMU control box
- [Q]- Liquid-cooling piping
- [R]- Liquid cooler
- [S]- Power box
- [T]- Power conversion system(PCS)
- [U]- EP-E300 serial port server (for FFR only)



## 2.2 Product specification

### 105kW/215kWh All-in-One Li-ion Battery Storage System

Battery data	
Cell type	LFP
Rated capacity	280Ah
Serial-parallel type	1P240S
Rated capacity per pack	43.008kWh
Pack number	5
System rated energy capacity	215.04kWh
Rated DC voltage	768V
DC voltage range	672~864V
Rated DC current	140A
Max. DC current	160A
AC data	
Rated AC power	105kW
Rated grid voltage	400Vac
Rated grid frequency	50/60Hz
Max. AC current	167A
AC wiring type	3W/N+PE
THDi	<3% (Rated AC power)
Power factor	-1~+1
General data	
DOD	95 % DOD
Degree of protection	IP55 (Battery room & PCS room)
Cooling/Heating concept	liquid cooling/liquid heating
Fire suppression system	aerosol
Operating temperature range	-20~55°C
Relative humidity	5~95%RH
Max. working altitude	2000m
Display	APP/Web/LED
COM interfaces	RS485/Ethernet/4G (optional)
Dimensions(W*D*H)	1399*1344*2080mm
Weight	2450±50kg

# 3. Transportation and Storage

## 3.1 Transportation

It is adapted to trucks and ships, and should be covered with canopy, protected from sunshine, and loaded and unloaded safely in transportation. In the process of loading and unloading, the energy storage cabinet should be gently moved and put down, and strictly prevented from falling, rolling and heavy loads. It should also be prevented from rain, snow and mechanical impact in transportation.

- 3.1.1 Environmental requirements for transportation of energy storage cabinet  
According to the battery characteristics, the energy storage cabinet should meet the following requirements in storage and transportation to maximize the protection of battery performance:

Average daily storage temperature:  $\leq 20^{\circ}\text{C}$ ; allowable storage temperature:  $-20\sim 55^{\circ}\text{C}$ ;

Humidity: less than 95% RH, non-condensing.

- 3.1.2 Requirements for energy storage cabinet transportation

### (1) Pre-loading inspection of energy storage cabinet

1) Check the information of the outside package and labels of the goods before loading, to ensure that the outside package of the goods is complete.

### (2) Loading of energy storage cabinet

1) Forklift is required to meet the load capacity of the energy storage cabinet for operation. It should be qualified in annual inspection. It is not allowed to move during the lifting operation.

2) The energy storage cabinet is heavy, which should be strapped securely with the corresponding filler and tapes if there are any gaps in the vehicle.

3) After loading, it is necessary to recheck to verify that tapes and protections are secured.

### (3) Transportation of energy storage cabinet

1) The vehicle speed shall not exceed the speed specified in traffic regulations.

Transportation on bumpy roads should be avoided as much as possible.

2) Sharp braking and turns are prohibited in transportation.

3) Keep the vehicle in good condition. Check load status regularly and provide timely feedback when problems are found.

### (4) Unloading of energy storage cabinet

1) Before picking up the goods, it is necessary to prepare suitable unloading tools according to the packing list.

### 3.2 Storage

The energy storage cabinet should be stored in a dry warehouse, without exposure to sunlight or rain. Harmful gases, flammable or explosive products and corrosive chemicals are not allowed in the warehouse. The cabinet should be prevented from mechanical shock, heavy pressure, strong magnetic field or exposure to direct sunlight. It should be at least 2m away from heat sources and 50cm away from walls, windows or air inlets.

**Average daily storage temperature:**  $\leq 20^{\circ}\text{C}$ ; **allowable storage temperature:**  $-20\sim 55^{\circ}\text{C}$ ;

**Storage humidity:** less than 95% RH, non-condensing.

**Under the conditions of these regulations:**

At least one supplemental charge to 50% SOC is required within 6 months after the product is shipped from the factory. Capacity verification and capacity re-inspections are required every 12 months.

## 4. Installation Instructions

### 4.1 Basic installation requirements

While selecting an outdoor cabinet installation site, consider the following environmental conditions. Accumulated dust or sand may cause premature failure. In addition, according to the fire protection requirements for lithium batteries, the outdoor cabinet should be far away from people.

Ambient conditions	Recommended range
Ambient temp.	$-20^{\circ}\text{C}\sim 55^{\circ}\text{C}$
Humidity	$\leq 95\% \text{RH}$ , non-condensing.
Dustiness	$\leq 1\text{mg}/\text{m}^3$
Corrosive substance	No contaminants, such as salt, acid, smoke, etc.
Vibration	$\leq 1.5\text{m}/\text{s}^2$
Insects, pests, termites	None
Mold	None
Damp	No rain
Fire protection	No flammables at the top and bottom of cabinet

## 4.2 Layout requirements

- Cabinet layout requirements

Keep a 600mm space behind the back of the cabinet for heat dissipation through the air outlet, as shown below.

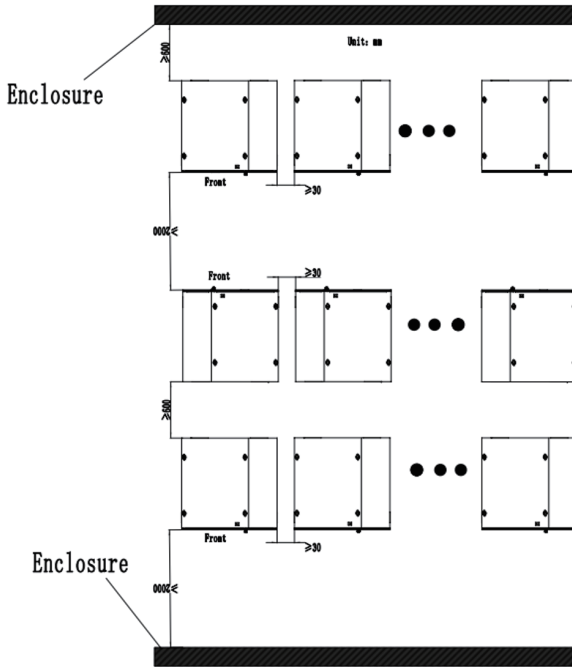

Figure 3.1 Space Requirements for Cabinet Installation

- Cable layout requirements

Connect the AC power cable and communication cable along cable trenches through the bottom of the cabinet.

- Power supply requirements

To ensure the electrical reliability of the EMU and firefighting system inside the energy storage cabinet, it is recommended to use an external UPS as the backup power supply. The AC power cable should be a copper-core cable, with its cross-sectional area adapted to the load. The outdoor power cable should be directly buried or laid in a casing, and separated from the signal cable as much as possible.

- Wiring requirements

1) For the power supply of the AC220V UPS of the outdoor cabinet, the AWG #16 cable is

recommended (min. 100W).

2) The cable length between the outdoor cabinet and the external distribution cabinet depends on project and site conditions. AWG #1 power cable is recommended (AWG #1 AC400V cables for A/B/C, and AWG #4 AC400V cables for N/PE)

3) Category 6 network cables are commended for the outdoor cabinet.

4) AWG #4 AC400V cable is recommended for the grounding wire of the cabinet shell.

- Safety protection requirements

- Lightning protection and surge protection.

- Lightning protection and grounding systems comply with current national or ministerial standards.

- Grounding requirements

Ground cables (AWG #4) shall be grounded reliably.

### 4.3 Cabinet installation

- Cabinet lifting

- Check whether the lifting ring is loose. If so, use the NO.15 tool in the tool list of the Quick Installation Guide to tighten it.

- Install the rope through the four rings and to a height of 800mm, so that the rope angle is greater than 60°.

- Lift the cabinet slowly via the rope (capacity:  $\geq 3T$ ) and put it down gently.

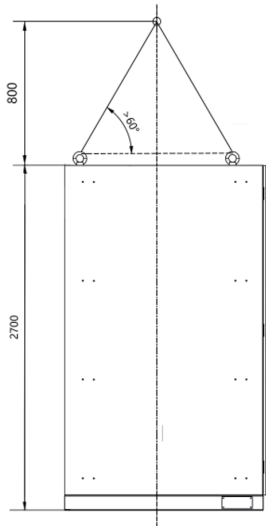

Figure 3.2 Cabinet Lifting

- Handling requirements

- Handling by forklift is preferred. The fork length (A) should be greater than 1.5m, as shown below:

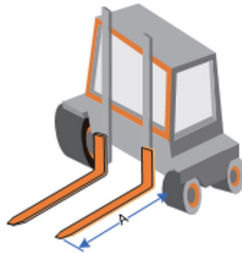

Figure 3.3 Fork Length A (more than 1.5m)

- The forklift shall have a capacity of at least 3t. The forks must extend out the forklift holes, as shown below:



Figure 3.4 Fork Extension out of Forklift Holes

- Handle the cabinet gently via the forklift.

- Cabinet dimensions

Cabinet dimensions: (W) 1399mm \* (D) 1344mm \* (H) 2080mm; weight: 2450±50kg

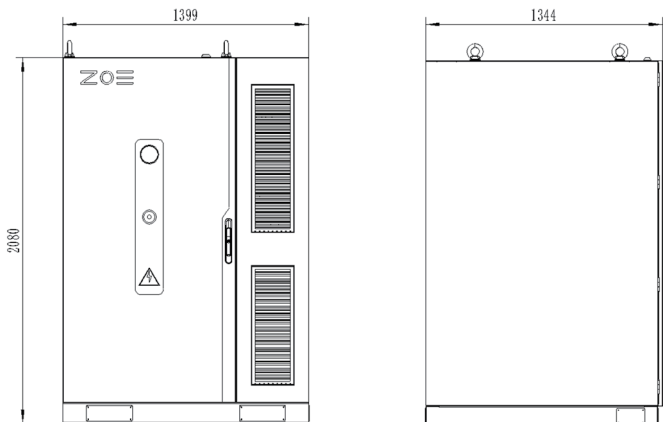

Figure 3.5 Cabinet Dimensions

- Proposed drawing for cabinet installation on base:

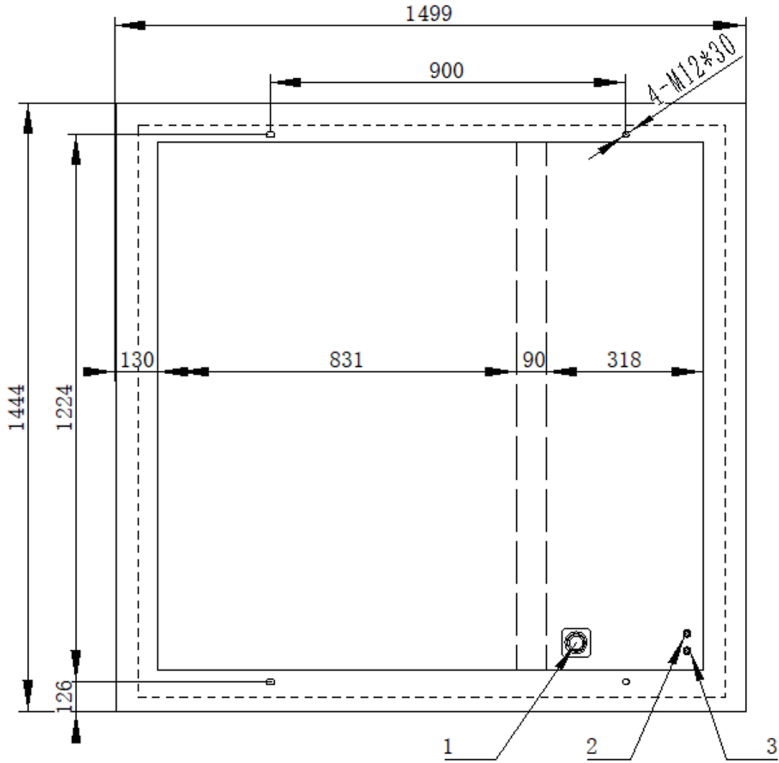

Figure 3.6 Base Dimensions

- Cement base requirements

Set up a 1499\*1444mm planar space with M12 anchor bolts embedded according to the dimensional drawing.

#### 4.4 Electrical connection

- 4.4.1 Installation requirements

➤ The AC lead-in wire is routed from the user's distribution switch and connected to the PCS input terminals. The distribution office should be equipped with protection devices against overcurrent, short circuits, and lightning strikes.

➤ Yellow, green, and red AC power lines and the light blue line match AC phases A, B, C and neutral lines respectively. If there is only one color for power cables, labels indicating cable numbers (or sleeves with markings) should be attached.

➤ AC power cables should be placed separately from communication cables.

➤ When cables are laid, no broken terminals, damage, or scratches are allowed.

- 4.4.2 Cable connection

1. Installation of power cables

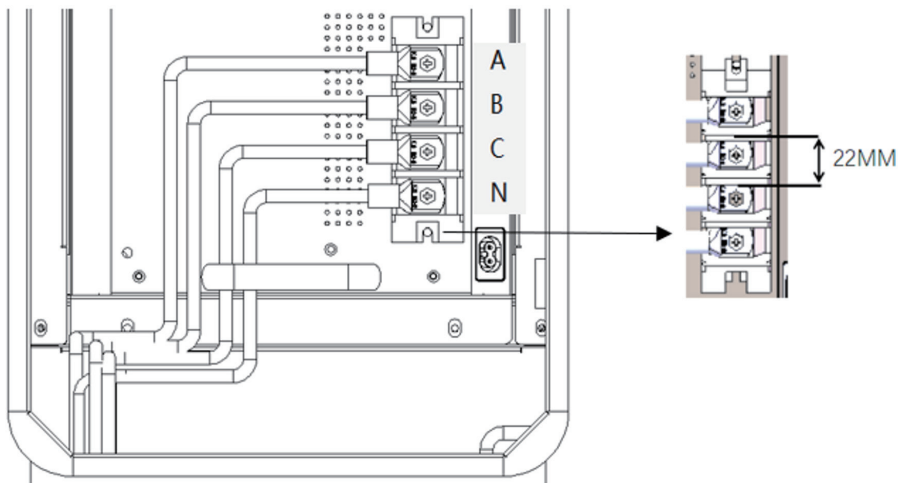

Figure 4.1 Power Cable Wiring Diagram

➤ Disconnecting switches (SWITCH) and air switches (QF1, QF2, and QF3) are OFF.

- The lead-in cable is brought in from the bottom of the cabinet and connected to the PCS input terminals A/B/C/N. The mounting torque of the terminal screws is: 18-22 N.M; PE is connected to the grounding stud of the cabinet shell. The mounting torque of the terminal screw is 8-10 N.M. A/B/C three-phase copper lug model: TLK50-8 (Brand KST), N-wire copper lug model: TLK25-8 (Brand KST), PE end copper lug model: TLK25-12 (Brand KST)

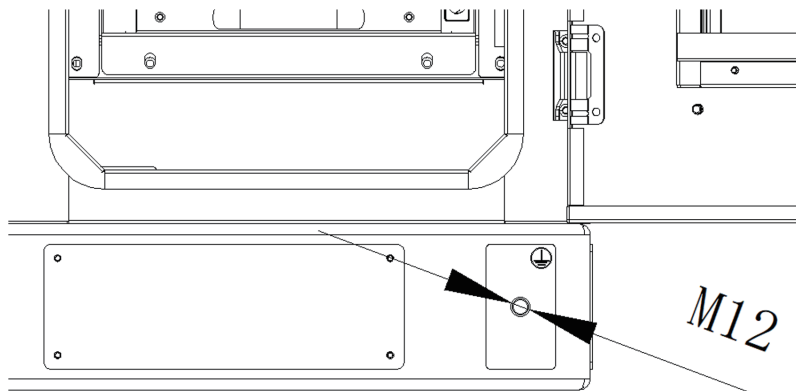

Figure 4.2 Cabinet Shell Grounding



## 2. Communication cable wiring

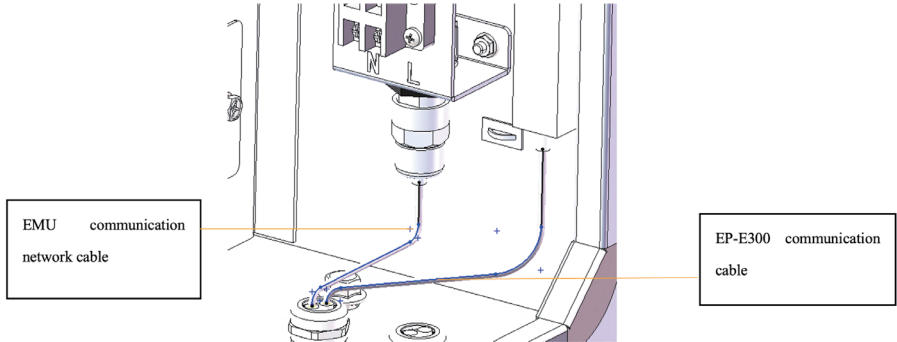

Figure 4.3 Communication Cable Wiring Diagram

- Lead the network cables for EMU and EP-E300 through waterproof connector, and plug into the connectors respectively. Lock the waterproof connector and seal with sealing glue.
- Connect the EP-E300 for FFR. EP-E300 is not needed for FCR.

## 3. UPS Cable Wiring

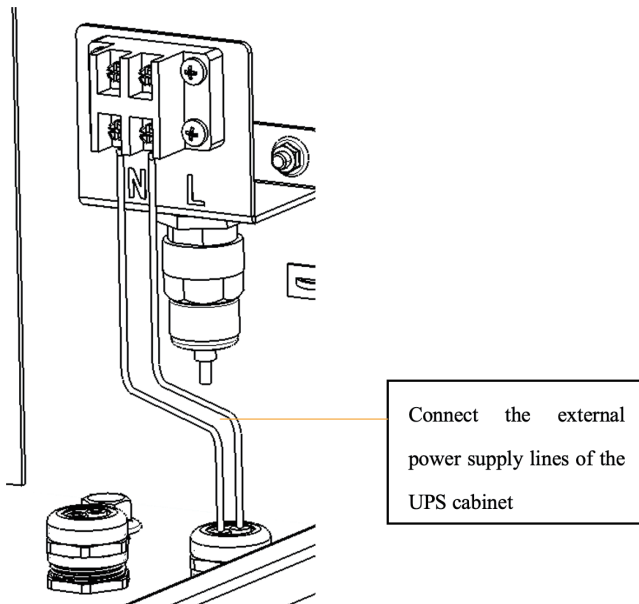

Figure 4.4 UPS Cable Wiring Diagram

- The UPS power supply cable is connected to the cabinet through the waterproof connector, which is plugged into the lower part of the UPS terminal. The wiring torque is 0.8-1.0N.M. The copper lug model is: E1510 (Brand KST)

#### • 4.4.3 Connection considerations

▲ Check whether the protection level of the equipment meets the requirements, especially the cable entrance at the bottom of the equipment, and whether the cable holes in the equipment are sealed.

▲ Any kind of short-circuit is strictly prohibited during the connection process.

▲ Operation by untrained operators is strictly prohibited.

▲ Operation by persons not wearing protective equipment in accordance with the relevant requirements is prohibited.

▲ All connections must be made under clear instructions. Any forms of guessing and fuzzy attempts are strictly prohibited.

▲ The key points of the connection are as follows: Ensure that the connection is correct and reliable (without looseness) with correct contact and without short circuits.

▲ After the connection is completed, it must be measured and confirmed point by point.

▲ Warning: Make sure that the circuit breaker switch is disconnected before starting the wiring operation during installation.

▲ Other uncertainties need to be confirmed by a professional before implementation.

## 5. Usage Instructions

### 5.1 Confirmation of cable connection

▲ Before powering on the system, check the connecting cables to ensure that they are reliably connected and free from aging, breakage, or insulation damage.

▲ Check that the input AC three-phase power cables to the battery cabinet are properly connected, tight and reliable.

▲ Check that all communication cables and connection terminals are connected tightly and reliably.

### 5.2 Equipment powering on/off instructions

Operation of the energy storage system consists of two parts: power-on and debugging. Power on the system before using it. Once the system is powered on, the debugging personnel appointed by the manufacturer will assist in debugging. After debugging, the equipment will work in the automatic mode, no operation is required by user.

#### • Power-on steps:

Step 1: First, confirm the external 400V AC power access. After closing the external circuit

breaker, the PCS power indicator lights up.

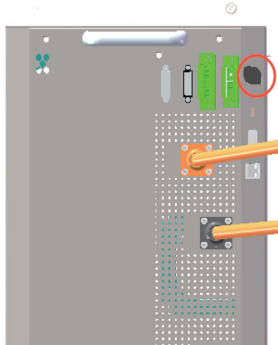

Figure 5.1 PCS Status Indicator

Step 2: Close the QF1 and QF2 circuit breaker switches on the electrical cabinet (After an external UPS is connected, QF3 must be closed; if no external UPS is connected, keep QF3 disconnected).

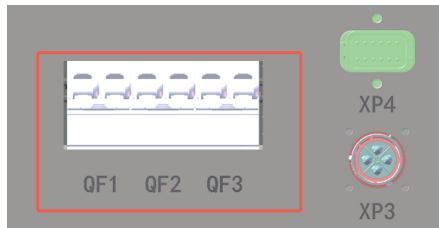

Figure 5.2 Schematic Diagram of Circuit Breaker Switches

Step 3: Close Switch (SWTICH) of the Upper High-voltage Box

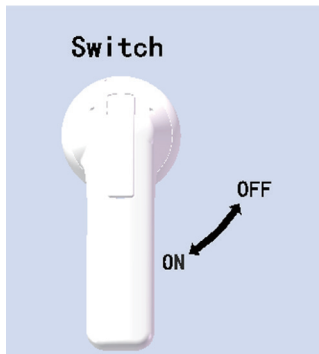

Figure 5.3 Closed State of the Disconnecting Switch

Step 4: Press the secondary circuit power button of the high-voltage box, the button indicator red light is on, and the front door operation status indicator light is on. At this moment, the system is powered on.

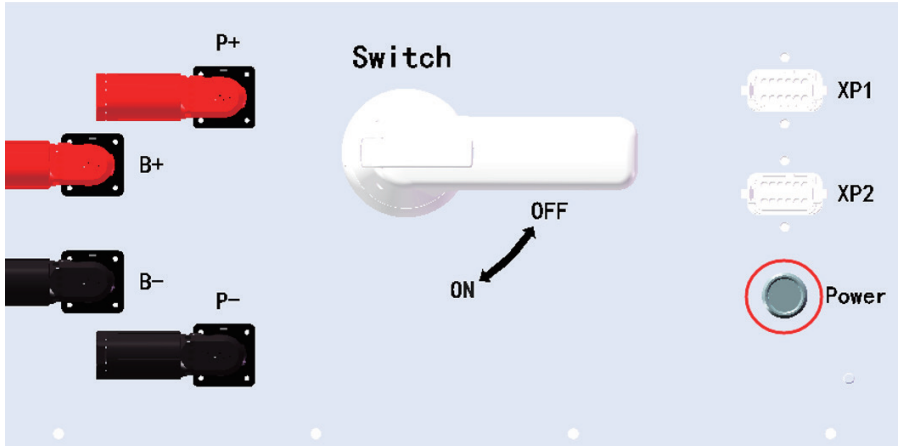

Figure 5.4 Secondary Circuit Power Button

The operational status indicator of the cabinet in the power-on status is defined in the table below:

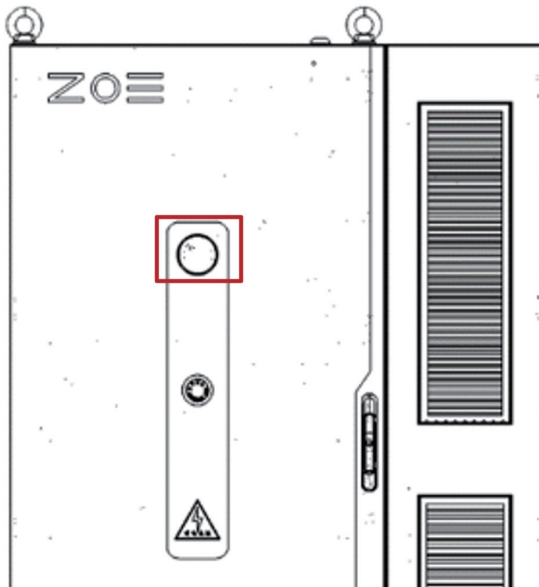

Figure 5.5 Operational Status Indicator

	Color	Status	Control Logic	Description	Cycle
	Off		Always off	Abnormal power supply to the indicator board	
	White		Always on	Abnormal communication of the indicator board	
Green		Always on	Standby		
		Breathing	Charge		2s/time
Blue		Breathing	Discharge		2s/time
Yellow		Flowing flash	System self-test		Power-on self-test time: about 2min
		On-off flash	Level 1 alarm (L1)	Liquid cooling alarm	0.5s on, 3s off
			Level 1 alarm (L2)	PCS alarm	0.5s on, 2s off
				BMS alarm	
			Level 1 alarm (L3)	Fire control alarm	0.5s on, 1s off
				Low SOC alarm	
				High SOC alarm	
				Total clusters - Overvoltage alarm	
			Total clusters - Undervoltage alarm	0.5s on, 1s off	
		Single cell - Overvoltage alarm			
Single cell - Undervoltage alarm					
Level 2 alarm (L1)	Liquid cooling protection	0.5s on, 0.5s off			
Level 2 alarm (L3)	Fire control protection	0.25s on, 0.25s off			
Always on	Level 2 alarm (L2)	PCS protection			
		BMS protection			
		Liquid cooling system out-of-control			
Red	On-off flash	Level 3 fault (L1)	Liquid cooling system fault	0.5s on, 3s off	
		Level 3 fault (L2)	PCS fault	0.5s on, 2s off	
		Level 3 fault (L3)	BMS fault	0.5s on, 1s off	
		Level 3 fault (L4)	Fire protection fault	0.5s on, 0.5s off	
		Level 3 fault (L6)	Fire alarm	0.25s on, 0.25s off	
	Always on	Level 3 fault (L5)	Emergency stop fault		
Hardware fault					

### Tips

When the operational status indicator is in the status of Level 1 alarm (L2), Level 2 alarm (L2) and Level 3 fault (L3), the liquid cooling system may be in the heating mode. The specific heating duration depends on the current ambient temperature. The lower the ambient temperature, the longer the heating duration.

- Power-off steps:

Step 1: Set the cabinet to the standby status and stop charging and discharging.

Step 2: Disconnect the external circuit breakers, including the external auxiliary power supply or UPS.

Step 3: Press the control power button on the DC high-voltage box. The red indicator of the corresponding secondary circuit button will be off, indicating that the system is powered off.

- Emergency stop steps:

Step 1: Confirm the fire alarm (Level 3 fault L6).

Step 2: Squeeze the emergency stop button panel with hands or break it with a hard object.

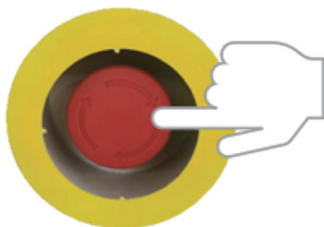

Figure 5.6 Before Crushing of Emergency Stop Button



Figure 5.7 After Crushing of Emergency Stop Button

Step 3: Press the emergency stop button.



**Figure 5.8 Pressing of Emergency Stop Button**

### 5.3 Upper computer operation instructions

➤ For details, see: Operation Instructions for the EMU Host Computer Software

## 5.4 Troubleshooting

Category	Faulted	Possible Cause	Solution
Overall cabinet	Power indicator off	No power supply	Check the circuit protection switch and turn it on if necessary. If it is damaged, please contact your service partner.
	Operational status indicator - red	PCS fault	Please contact your service partner.
		Emergency stop fault	Check whether the emergency stop button is pressed.
		Fire alarm	Please contact your service partner.
		Liquid cooling fault	Please contact your service partner.
		BMS fault	Please contact your service partner.
		Fire protection fault	Please contact your service partner.
Liquid cooling system	Fan fault	No main power supply	Check the power supply voltage.
		Control board failure	Check the control board for abnormal output voltage or burns.
	Compressor failure	No main power supply	Check the power supply voltage.
		High compressor noise	Check the power supply voltage. Check whether the suction pressure is correct.
		Compressor overheat	Check whether the fan is running properly. Check whether the condenser is blocked.
High voltage box	High-voltage box fault	QF breaker fault	Check whether the switch is closed.
		Invalid collection of total voltage	Check whether the B+, B- and battery pack cables are damaged or disconnected.
		Communication failure	Check the power supply. Check whether the power button is triggered. Check the communication line for short circuit, etc.

# 6. Product Maintenance

## 6.1 Explanation of terms

- Normal operation: The energy storage cabinet operates every day.
- Intermittent operation: The energy storage cabinet operates at a variable frequency every month and cannot be guaranteed to operate every day.
- No use for a long time: The energy storage cabinet has not been activated for more than 3 consecutive months (The cabinet must be charged to 50% SOC before being suspended from usage).

## 6.2 Usage requirements for the energy storage cabinet in normal operation

- Please maintain the battery of the energy storage cabinet once every twelve months to prevent damaging the battery. Please refer to Section 6.6 for specific maintenance methods.
- Inspect the energy storage cabinet every twelve months (refer to Appendix 2) and keep a record of the inspection.

## 6.3 Usage requirements for the energy storage cabinet in intermittent operation

- The usage requirements are the same as those for the cabinet in normal operation.

## 6.4 Usage requirements for the energy storage cabinet unused for a long time

- The SOC range of storing energy storage cabinets: 30%~50%. It is forbidden to store the cabinets for a long time below 15% SOC. The cabinets need to be disconnected from the power-consuming equipment in time when they are not used for a long time.
- Inspect the energy storage cabinet every three months (refer to Appendix 2) and keep a record of the inspection.
- Maintain the battery of the energy storage cabinet once every three months to prevent damaging the battery. Please refer to Section 6.6 for specific maintenance methods.
- Before the first usage of the energy storage cabinet unused for a long time, please fully charge it once minimally to activate the cabinet and restore the performance of the battery to the best condition.

### Tips

If the energy storage cabinet is unused for a long time, it will cause irreversible damage to the battery. Please make sure to carry out regular maintenance.

## 6.5 Function of the disconnecting switch

1) The disconnecting switch is a kind of electrical component used to manually cut off the high-voltage line and serves a safety protection function (see the following figure). When



the handle points to OFF, the disconnecting switch is off; when the handle points to ON, the disconnecting switch is on.

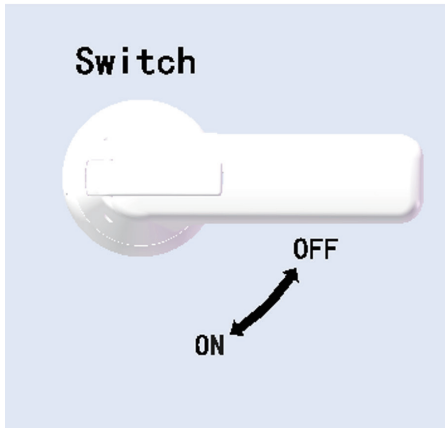

Figure 6.1 Disconnecting Switch Disconnected

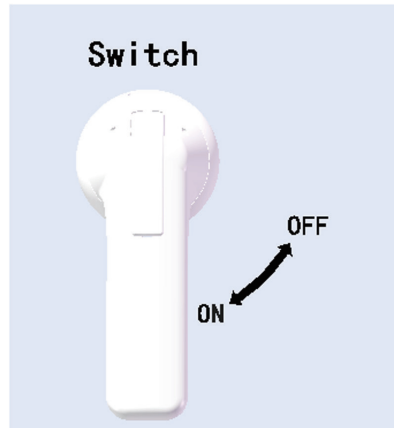

Figure 6.2 Disconnecting Switch closed

2) Before maintaining the system, the relevant personnel need to disconnect the disconnecting switch first.

When the maintenance is completed, make sure that the disconnecting switch is ON.

## 6.6 Maintenance of energy storage system

To ensure the long-term safe and reliable operation of your energy storage cabinet, please read and observe the following operating instructions carefully:

Maintenance procedure:

Option 1: This power-saving option is recommended when the SOC of the cabinet is  $\leq 50\%$ .

1. Discharge the cabinet to the cut-off conditions (minimum single voltage 2.8V) at the rated power of 105kW, stop discharging, and stand it still for 1 hour.
2. Charge the cabinet fully at the rated power of 105kW (maximum single unit voltage 3.65V). After charging, stand it still for 1 hour.
3. Discharge the cabinet to 40% and stop.

Option 2: This power-saving option is recommended when the battery system SOC is  $> 50\%$ .

1. Charge the cabinet fully at the rated power of 105kW (maximum single unit voltage 3.65V). After charging, stand it still for 1 hour.
2. Discharge the cabinet to the cut-off conditions (minimum single voltage 2.8V) at the rated power of 105kW, stop discharging, and stand it still for 1 hour.

3. Charge the battery system to 40% and stop.

### Tips

Before maintenance, check whether the environment is safe and whether the system is safe with no alarms or faults.

## 6.7 Maintenance of liquid cooling system

➤ In case of any leakage inside the cabinet, please shut it down immediately and contact ZOE for maintenance.

➤ Check the liquid level inside the liquid cooler. If there is no liquid level (the coolant is indicated by red), it is necessary to add coolant. Please contact operation and maintenance personnel for replenishment.

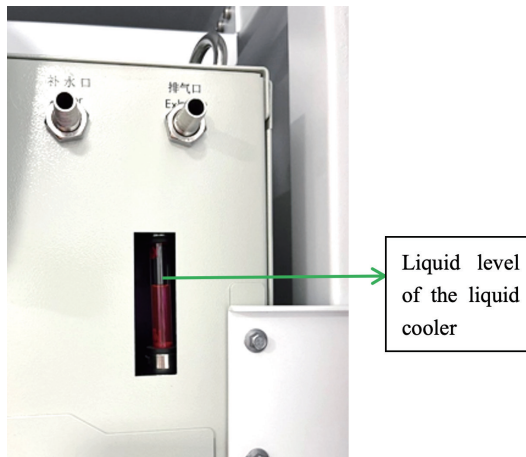

Figure 6.3 Liquid Level of the Liquid Cooler

## 6.8 Maintenance of firefighting system

➤ The service life of the aerosol is 15 years and needs to be maintained and replaced every 15 years.

➤ The temperature and smoke sensors should be inspected quarterly:

➤ Open the cabinet door, close the switch and press the button on of the high voltage box and observe the temperature and smoke sensor indicator. When the indicator flashes every few seconds, it indicates that the system works normally.

## 6.9 Check of air inlet and outlet

➤ Check all inlets and outlets for blockage on a quarterly basis.

➤ Clean the filter cotton in the inlet and outlet of the PCS bin every quarter. Details are as follows:

1) Open the right-side door, remove the two screws indicated by circles in Fig. 6.4, and open the filter cotton sheet metal of the air inlet bin by about 30°. Remove the filter cotton, clean up the dust, and install it back. If the filter cotton is clogged with dirt and cannot be cleaned, replace it with a new one.

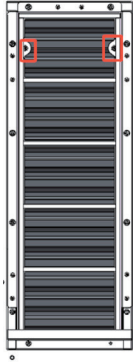

Figure 6.4 Screw Position

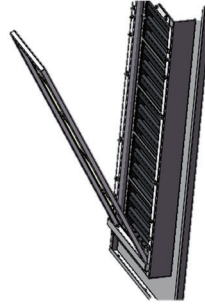

Figure 6.5 Schematic Diagram of Opening the Door

2) From the back of the cabinet, remove the air outlet grilles of the PCS bin at the lower part with a screwdriver. Remove the filter cotton, clean up the dust, and install it back. If the filter cotton is clogged with dirt and cannot be cleaned, replace it with a new one.

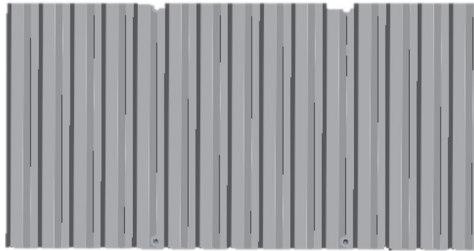

Figure 6.6 Air Outlet Grilles of the PCS Bin

## 6.10 Check of electrical grounding system

➤ Every quarter, check the grounding system for poor contact arising from rust and oxidation or increase in the grounding resistance. Check whether grounding signs are complete and legible, without any loss or damage.

➤ Check the grounding of electrical equipment every year. Check whether ground cables and terminals are in good condition.

### 6.11 Appearance inspection

➤ Check the cabinet for stains each quarter. Clean the whole cabinet. Check the sheet metal for deformation, rusting or paint peeling. Conduct painting in time to prevent rusting of the exterior surface.

### 6.12 Maintenance interval

➤ Maintenance cycle table

Inspection items	Quarterly	Semiannually	Annually	Operation
Cabinet appearance	√	√	√	Cleaning
Air outlet	√	√	√	Cleaning
Air inlet	√	√	√	Cleaning
Cable	√	√	√	Test
Dust-proof cotton	√	√	√	Cleaning
Distribution switch	√	√	√	Visual inspection
Grounding system	√	√	√	Test
Liquid cooling system	√	√	√	Visual inspection
Smoke detector	√	√	√	Visual inspection
Temperature-sensitive fire detector	√	√	√	Visual inspection
Battery system	√	√	√	For details, see Section 6.6 in the User Manual.

# 7. After-sales Service

Users can get the service through our after-sales service phone number.

Service e-mail: [service@zoeess.com](mailto:service@zoeess.com)

Refer to the contract for the years of free warranty service.

**The following conditions are not covered by our free warranty service:**

- System damage or failure arising from nonconformity to the requirements in the user manual.
- Failure of wiring and power supply in accordance with relevant electrical safety regulations, or damage caused by poor site conditions or consequent faults.
- Private modifications made by the user, resulting in damage to the system or consequent faults.
- System damage or failure caused by irresistible natural factors such as typhoons, earthquakes, floods, fires or harsh environments (high temperature, low temperature, high humidity, acid rain, etc.).
- The user fails to maintain the initial fault status after a fault occurs, and fails to notify the manufacturer in time but handles the problem on his/her own, making it impossible to make a realistic fault identification of the cause of the fault.



VISIT  
WEBPAGE



FOLLOW  
US

Energy for Life